



0121 270 8507



SALES@DIRECTCHANNEL.UK.COM



DIRECT CHANNEL
SUPPORT SYSTEMS LIMITED



FASTNER & FIXINGS

RAWLPLUG®

walraven

fischer 
innovative solutions

STRUT FIX

Fasteners & Fixings

Precision Hardware Built for Structural Integrity

At Direct Channel, we supply one of the UK's most comprehensive ranges of fasteners and fixings – engineered for maximum strength, reliability, and long-term performance. Our product selection covers everything from industrial bolts and threaded rods to anchor systems, washers, and wall fixings – all designed to work seamlessly with our full range of support and containment systems.

Whether you're installing cable containment, suspending HVAC systems, fixing into concrete, or assembling structural frames, our fasteners provide the durability and compatibility required for demanding environments.

Comprehensive Range Includes:

- Threaded Rods & Cut Studs (BZP, HDG, Stainless Steel – M6 to M16)
- Hex Head Set Screws, Nuts & Washers
- Channel Nuts – Plain, Spring, Long Spring (M6, M8, M10, M12)
- Concrete Screwbolts & Throughbolts (incl. ETA-approved Rawlplug & Fischer ranges)
- Roofing Bolts, Eye Bolts & Hook Bolts
- Drop-In Anchors, Sleeve Anchors & Shield Anchors
- Self-Drilling Screws, Self-Tapping Screws & Timber Fixings
- Plasterboard Fixings, Wall Plugs, Chemical Resin Fixings
- Galv Spray Paints, Fixing Bands, Cable Ties, and Accessories

Why Choose Our Fasteners?

- Available in Bright Zinc Plated (BZP), Hot Dip Galvanised (HDG) & A4 Stainless Steel
- Designed to match UK-standard Unistrut® compatible systems
- Supplied in bulk or boxed pack formats
- In-stock and ready for fast UK-wide delivery



0121 270 8507



SALES@DIRECTCHANNEL.UK.COM

THREAD ROD



THREAD SIZE	LENGTH	(FINISH) BZP	(FINISH) HDG	(FINISH) A4 STEEL
M6	1 M 2 M 3 M	TR1-6 TR2-6 TR3-6	- - -	TR1-6A4 - TR3-6A4
M8	1 M 2 M 3 M	TR1-8 TR2-8 TR3-8	TR1H-8 TR2H-8 TR3H-8	TR1-8A4 TR2-8A4 TR3-8A4
M10	1 M 2 M 3 M	TR1-10 TR2-10 TR3-10	TR1H-10 TR2H-10 TR3H-10	TR1-10A4 TR2-10A4 TR3-10A4
M12	1 M 2 M 3 M	TR1-12 TR2-12 TR3-12	TR1H-12 TR2H-12 TR3H-12	TR1-12A4 TR2-12A4 TR3-12A4
M16	1 M 2 M 3 M	TR1-16 TR2-16 TR3-16	TR1H-16 TR2H-16 TR3H-16	TR1-16A4 TR2-16A4 TR3-16A4
M20	1 M 2 M 3 M	TR1-20 TR2-20 TR3-20	TR1H-20 TR2H-20 TR3H-20	TR1-20A4 TR2-20A4 TR3-20A4
M24	1 M 2 M 3 M	TR1-24 TR2-24 TR3-24	TR1H-24 TR2H-24 TR3H-24	TR1-24A4 TR2-24A4 TR3-24A4

THREAD ROD

GRADE 8.8 (HIGH TENSILE)



THREAD SIZE	LENGTH	(FINISH) HDG
M8	1 M	TR1H-8T
M10	1 M	TR1H-10T
M12	1 M	TR1H-12T
M16	1 M	TR1H-16T
M20	1 M	TR1H-20T
M24	1 M	TR1H-24T

THREADED CUT STUDS & BOLTS

THREADED CUT STUD

FINISH : BRIGHT ZINC PLATED (BZP)



THREAD SIZE	LENGTH	PRODUCT CODE
M8	40MM	SB0840.Q100
	80MM	SB0880.Q100
	100MM	SB08100.Q100
	150MM	SB08150
	250MM	SB08250
	300MM	SB08300
	500MM	SB08500
M10	40MM	SB1040.Q100
	80MM	-
	100MM	-
	150MM	SB10150
	250MM	SB10250
	300MM	SB10300
	500MM	SB10500
	750MM	SB10750

THREADED CUT STUDS & BOLTS

THREADED CUT STUD

FINISH : BRIGHT ZINC PLATED (BZP)



THREAD SIZE	LENGTH	PRODUCT CODE
M12	100MM 150MM 250MM 300MM 500MM	SB12100.Q50 SB12150 - SB12300 SB12500
M16	500MM 800MM	SB16500 SB16800
M24	250MM	SB24250

THREADED CUT STUDS & BOLTS



THREADED CUT STUD

FINISH: Hot Dipped Galvanised (HDG)

THREAD SIZE	LENGTH	PRODUCT CODE
M10	300MM 500MM	SB10300G SB10500G
M12	300MM	SB12300G
M24	250MM	SB24250G

FISCHER BLR 100 BOLT LEFT/RIGHT



SIZE	PRODUCT CODE
M10	BLR100-M10.Q1
M12	BLR100-M12.Q1

THREADED ROD CONNECTORS & REDUCERS



THREADED ROD CONNECTOR

THREAD SIZE	BZP	STAINLESS STEEL A4
M6	-	RCM6-A4
M8	RCM8.Q1	RCM8-A4
M10	RCM10.Q1	RCM10-A4
M12	RCM12.Q1	RCM12-A4
M16	RCM16.Q1	RCM16-A4
M20	RCM20.Q1	RCM20-A4
M24	RC24.Q1	RC24-A4

HEX HEAD SCREWS

**Kit Assembly Pack
(Bolt / Washer / Nut)**



THREAD SIZE	LENGTH	(FINISH) BZP	(FINISH) HDG
M6	16MM BOLT 20MM BOLT 25MM BOLT 35MM BOLT 40MM BOLT 50 MM BOLT	KIT-HB616B KIT-HB620B KIT-HB625B KIT-HB635B KIT-HB640B KIT-HB650B	KIT-HB616G KIT-HB620G KIT-HB625G KIT-HB635G KIT-HB640G -
M8	16MM BOLT 20MM BOLT 25MM BOLT 35MM BOLT 40MM BOLT 50 MM BOLT	KIT-HB816B KIT-HB820B KIT-HB825B KIT-HB835B KIT-HB840B KIT-HB850B	KIT-HB816G KIT-HB820G KIT-HB825G KIT-HB835G KIT-HB840G KIT-HB850G
M10	16MM BOLT 20MM BOLT 25MM BOLT 35MM BOLT 40MM BOLT 50 MM BOLT	KIT-HB1016B KIT-HB1020B KIT-HB1025B KIT-HB1035B KIT-HB1040B KIT-HB1050B	KIT-HB1016G KIT-HB1020G KIT-HB1025G KIT-HB1035G KIT-HB1040G KIT-HB1050G
M12	16MM BOLT 20MM BOLT 25MM BOLT 35MM BOLT 40MM BOLT 50 MM BOLT	KIT-HB1216B KIT-HB1220B KIT-HB1225B KIT-HB1235B KIT-HB1240B -	KIT-HB1216G KIT-HB1220G KIT-HB1225G KIT-HB1235G KIT-HB1240G -
M16	35MM BOLT 50 MM BOLT	KIT-HB1635B KIT-HB1650B	-

HEX HEAD BOLT



THREAD SIZE	LENGTH	BZP	HDG	STAINLESS STEEL
M6	16MM BOLT	HB616B	HB616B	-
	20MM BOLT	HB620B	HB620B	-
	25MM BOLT	HB625B	HB625B	HB625BA4.Q1
	30MM BOLT	HB630B	HB630B	-
	35MM BOLT	HB635B	HB635B	HB635BA4.Q1
	40MM BOLT	HB640B	HB640B	-
	50 MM BOLT	HB650B	-	-
M8	16MM BOLT	HB816B	HB816G	-
	20MM BOLT	HB820B	HB820G	-
	25MM BOLT	HB825B	HB825G	HB825BA4.Q1
	30MM BOLT	HB830B	HB830G	-
	35MM BOLT	HB835B	HB835G	HB835BA4.Q1
	40MM BOLT	HB840B	HB840G	-
	50 MM BOLT	-	-	-
M10	16MM BOLT	HB1016B	HB1016G	-
	20MM BOLT	HB1020B	HB1020G	-
	25MM BOLT	HB1025B	HB1025G	HB1025BA4.Q1
	30MM BOLT	HB1030B	HB1030G	-
	35MM BOLT	HB1035B	HB1035G	HB1035BA4.Q1
	40MM BOLT	HB1040B	HB1040G	-
	50 MM BOLT	HB1050B	-	-
M12	16MM BOLT	-	HB1216G	-
	20MM BOLT	HB1220B	HB1220G	-
	25MM BOLT	HB1225B	HB1225G	HB1225BA4.Q1
	30MM BOLT	HB1230B	HB1230G	-
	35MM BOLT	HB1235B	HB1235G	HB1235BA4.Q1
	40MM BOLT	HB1240B	HB1240G	-
	50 MM BOLT	HB1240B	-	-
M16	35MM BOLT	HB1635B	-	-
	50 MM BOLT	HB1650B	HB1650.Q1	-

CONE POINT SCREWS



THREAD SIZE

M10

FINISH

BZP

PRODUCT CODE

CPS1040.Q1

STAINLESS STEEL

CPS1040.Q1-A4.Q1

PLASTIC HEX HEAD CAPS



THREAD SIZE

M8

COLOUR

WHITE

BLACK

PRODUCT CODE

HCM8W

HCM8B

M10

WHITE

BLACK

HCM10W

HCM10B

WASHERS

PENNY WASHERS	THREAD SIZE	BZP	HDG	STAINLESS STEEL
	M6	PWM625	PWM625G	PWM625-A4
	M8	PWM825	PWM825G	PWM825-A4
	M10	PWM1025	PWM1025G	PWM1025-A4
	M12	PWM1225	PWM1225G	PWM1225-A4
	M16	PWM1630	-	PWM16-A4.Q1

SQUARE PLATE WASHER <u>THICKNESS 3MM</u>	THREAD SIZE	BZP
	M6	SPW06-3B40
	M8	SPW08-3B40
	M10	SPW10-3B40
	M12	SPW12-3B40

WASHERS

SQUARE PLATE WASHER <u>THICKNESS 5MM</u>	THREAD SIZE	BZP	HDG	STAINLESS STEEL
	M6	SPW06-5B40	D001/06	SPW06-A4
	M8	SPW08-5B40	D001/08	SPW08-A4
	M10	SPW10-5B40	D001/10	SPW10-A4
	M12	SPW12-5B40	D001/12	SPW12-A4
	M16	-	D01/XL16	-

TOP HAT SQUARE PLATE WASHER <u>3MM THICK</u>	THREAD SIZE	BZP
	M6	SPW06-TH.Q1
	M8	SPW08-TH.Q1
	M10	SPW10-TH.Q1
	M12	SPW12-TH.Q1

WASHERS

SPRING WASHERS	THREAD SIZE	BZP	STAINLESS STEEL A4
	M6	PSW6.Q500	-
	M8	PSW8.Q500	PSW8-A4
	M10	PSW10.Q500	PSW10-A4
	M12	PSW12.Q500	-

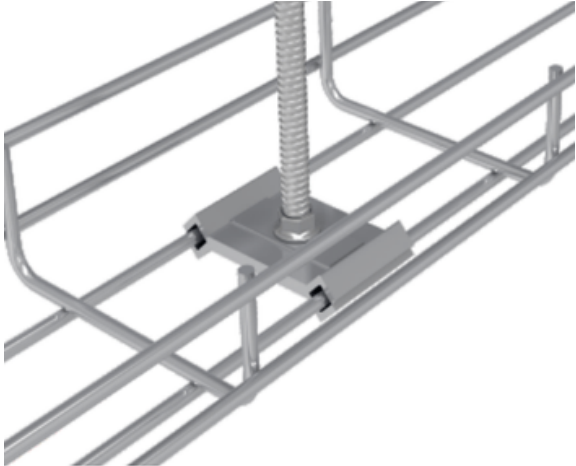
CENTRAL HANGING PLATE	THREAD SIZE	ELECTRO ZINC PLATED
	M6	CHP06-Z
	M10	CHP810-Z



TOP WIRE THREADED ROD HANGER

CODE: CTB/ATK10



PEMSA – M8 / M10 – C8 BLACK
CENTRAL HANGING PLATE

CODE: CHP810-BLK



PEMSA – CLICK CENTRAL HANGING
PLATE – BLACK C8

CODE: C8B/CLIKC

CHANNEL NUTS

PLAIN CHANNEL NUTS	THREAD SIZE	BZP	HDG	STAINLESS STEEL
	M4	CNP4	-	-
	M6	CNP6	CNP6G	CNP6A4
	M8	CNP8	CNP8G	CNP8A4
	M10	CNP10	CNP10G	CNP10A4
	M12	CNP12	CNP12G	CNP12A4
	M16	CNP16	CNP16G	CNP16A4

SHORT SPRING CHANNEL NUTS	THREAD SIZE	BZP	HDG	STAINLESS STEEL
	M6	CNS6	CNS6G	CNS6A4
	M8	CNS8	CNS8G	CNS8A4
	M10	CNS10	CNS10G	CNS10A4
	M12	CNS12	CNS12G	CNS12A4

CHANNEL NUTS

LONG SPRING CHANNEL NUTS	THREAD SIZE	BZP	HDG	STAINLESS STEEL
	M6	CNL6	CNL6G	CNL6A4
	M8	CNL8	CNL8G	CNL8A4
	M10	CNL10	CNL10G	CNL10A4
	M12	CNL12	CNL12G	CNL12A4

STUT CHANNEL NUTS

TOP HAT HAMMERHEAD

BRIGHT ZINC PLATED (BZP)

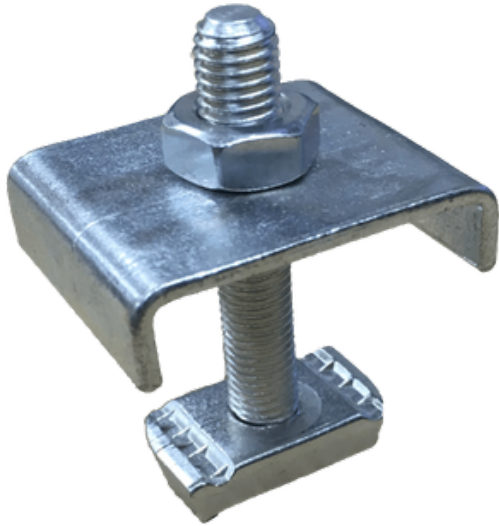

THREAD SIZE	LENGTH	PRODUCT CODE
M8	40MM	KNH840TH
	60MM	KNH860TH
M10	40MM	KNH1040TH
	60MM	KNH1060T
M12	40MM	KNH1240TH
	60MM	KNH1260TH

HAMMERHEAD

BRIGHT ZINC PLATED (BZP)



THREAD SIZE	LENGTH	PRODUCT CODE
M8	40MM	KNH840TW
	60MM	KNH860TW
M10	40MM	KNH1040TW
	60MM	KNH1060TW
M12	40MM	KNH1240TW
	60MM	KNH1260TW

THREADED NUT RANGE

HEX HEAD FULL NUTS	THREAD SIZE	BZP	HDG	STAINLESS STEEL
	M6	HNM6	HNM6G	HNM6-A4
	M8	HNM8	HNM8G	HNM8-A4
	M10	HNM10	HNM10G	HNM10-A4
	M12	HNM12	HNM12G	HNM12-A4
	M16	HNM16.Q1	HNM16G.Q1	HNM16-A4.Q1
	M20	HNM20.Q1	HNM20G.Q1	HNM20-A4.Q1
	M24	HNM24.Q1	HNM24G.Q1	HNM24-A4.Q1

HEX HEAD FULL NUTS	THREAD SIZE	BZP
	M6	HNY06
	M8	HNY08
	M10	HNY10
	M12	HNY12
	M16	HNY16.Q1
	M20	HNY20.Q1
	M24	HNY24.Q1

THREADED NUT RANGE

FLANG NUTS	THREAD SIZE	BZP
	M6	HNF6
	M8	HNF8
	M10	HNF10
	M12	HNF12
	M16	HNF16.Q1
	M20	HNF20.Q1
	M24	-
WEDGE NUTS	THREAD SIZE	BZP
	M6	WNM6.Q1
	M8	WNM8.Q1
	M10	WNM10.Q1
	M12	WNM12.Q1
	M16	-
	M20	-
	M24	-

THREADED NUT RANGE

DOME NUTS	THREAD SIZE	BZP
	M6	HND6
	M8	HND8
	M10	HND10
	M12	HND12
	M16	HND16.Q1
	M20	HND20.Q1
	M24	HND24.Q1

CONCRETE SCREWS / THUNDERBOLTS

FEMALE CONCRETE SCREWS

THREAD SIZE LENGTH PRODUCT CODE



M8/M10

35MM

FBS6X35F.Q1

55MM

FBS6X55F.Q1



M8/M10

35MM

FCS6X35F.Q50

55MM

FCS6X55F.Q50



MALE CONCRETE SCREWS



THREAD SIZE LENGTH PRODUCT CODE

M8

35MM

FBS6X35M.Q1

55MM

FBS6X55M.Q1

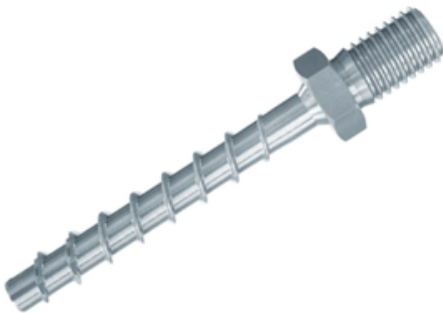

CONCRETE SCREWS / THUNDERBOLTS

ULTRACUT CONCRETE SCREWS

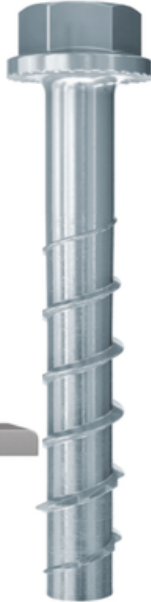
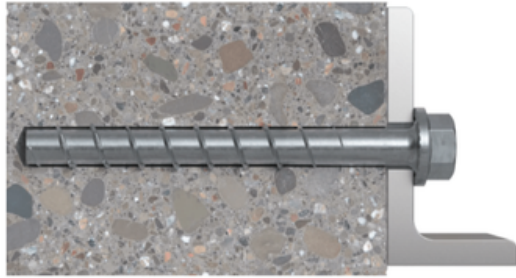

LENGTH

PRODUCT CODE

8X70MM

FBS870

8X80MM

FBS880

8X90MM

FBS890

8X110MM

FBS8110

10X70MM

FBS1070

10X90MM

FBS1090

10X100MM

FBS10100

10X120MM

FBS10120

10X140MM

FBS10140

10X160MM

FBS10160

12X85MM

FBS1285

12X110MM

FBS12110

14X120MM

FBS14120

14X125MM

FBS14125

RAWLPLUG THROUGHBOLT ZINC FLAKE

RAWLPLUG®



LENGTH

PRODUCT CODE

8X65MM

R-HPTM8/65

8X80MM

R-HPTM8/80

8X115MM

R-HPTM8/115

10X65MM

R-HPTM10/65

10X80MM

R-HPTM10/80

10X95MM

R-HPTM10/95

10X115MM

R-HPTM10/115

10X130MM

R-HPTM10/130

12X80MM

R-HPTM12/80

12X100MM

R-HPTM12/100

12X120MM

R-HPTM12/120

12X135MM

R-HPTM12/135

12X150MM

R-HPTM12/150

16X105MM

R-HPTM16/105

16X140MM

R-HPTM16/140

16X180MM

R-HPTM16/180

20X125MM

R-HPTM20/125

MALE BACK PLATE

BRIGHT ZINC PLATED (BZP)



THREAD SIZE	LENGTH	PRODUCT CODE
M8	40MM	BPM840
	60MM	BPM860
	80MM	BPM880
	100MM	BPM8100
M10	40MM	BPM1040
	60MM	BPM1060
	80MM	BPM1080
	100MM	BPM10100
M12	40MM	BPM1240
	60MM	BPM1260
	80MM	BPM1280
	100MM	BPM12100

SWIVEL HANGERS



THREAD SIZE	PRODUCT CODE
M6	SBH08
M8	SBH10
M10	SBH12



SWIVEL HANGERS ATTACHMENT
LINDAPTER - M10 SWIVEL ATTACHMENT
PRODUCT CODE - SW10

SELF TAPPING / DRILLING SCREWS

TIMCO (WAFER HEAD SCREWS)	Length	Variant Code
	13MM	00812HWSD
	16MM	0016WHSD
	19MM	00019WHSD
	22MM	S22W16B
	25MM	0025WHSD



TIMCO – 4.2 X 13 METAL CONSTRUCTION LIGHT SECTION SCREWS – HEX – SELF-DRILLING – ZINC

Code: 00812HWSD



TIMCO – 5.5 X 32MM LIGHT DUTY TECH SCREWS X 100

Code: L32W16B



TIMCO – 5.5 X 25MM LIGHT DUTY TECH SCREWS X 100

Code: L25W16B



TIMCO – 6.3 X 22MM STITCHING TECH SCREW X 100

Code: S22W16B



TIMCO – 5.5 X 32MM HEAVY DUTY TECH SCREW X 100

Code: H32W16B



TIMCO – 5.5 X 38MM LIGHT DUTY TECH SCREW X 100

Code: L38W16B



TIMCO – 5.5 X 38MM HEAVY DUTY TECH SCREW X 100

Code: H38W16B



TIMCO 5.5 X 38MM HEX HEAD SELF-DRILLING SCREWS WITH EPDM WASHER – PACK OF 100

Code: H38W16BB



TIMCO – 6.3 X 45MM TECH SCREW WITH WASHER X 100

Code: DS45W16B



TIMCO – 5.5 X 55MM HEAVY DUTY TECH SCREW X 100

Code: H55W16B

SELF TAPPING / DRILLING SCREWS

RAWL PLUG (SELF DRILLING TECH SCREWS)	Length	Variet Code
	16MM	R-S1-OC-48016
	22MM	R-S1-OC-55022
	25MM	R-S1-OC-55025
	32MM	R-S1-OC-55032
	38MM	R-S1-OC-55038
	45MM	R-S1-OC-55045
	55MM	R-S1-OC-55055



**RAWL PLUG – 5.5 X 22MM
SELF DRILLING TECH
SCREWS WITH WASHERS X
100**

Code: R-S1-OC-55022T



**RAWL PLUG – 4.8 X 16MM
SELF DRILLING TECH
SCREWS WITH WASHERS X
100**

Code: R-S1-OC-48016T



**RAWL PLUG – 5.5 X 25MM
SELF DRILLING TECH
SCREWS WITH WASHERS X
100**



Code: R-S1-OC-55025T





**RAWL PLUG – 14MM
WASHERS FOR SELF
DRILLING TECH SCREW X
100**



Code: R-S1-PEA-14

DROP IN ANCHOR / SLEEVE ANCHOR / SHIELD ANCHOR

Setting Tool for Drop In Anchor	VARIANT	PRODUCT CODE
 <p>fischer </p> <p><u>FISCHER EA II</u></p>	M8 X 25/30MM	EAI1830-25-ST
	M8 X 40MM	EAI1840-ST
	M10 X 25/30MM	EAI1030-25-ST
	M10 X 40 MM	EAI1040-ST

Setting Tool for Drop In Anchor	VARIANT	PRODUCT CODE
 <p>fischer </p> <p><u>FISCHER SDS EA II</u></p>	M8 X 25/30MM	EAI1830-25-SDS-ST
	M8 X 40MM	EAI1840-SDS-ST
	M10 X 25/30MM	EAI1030-25-SDS-ST
	M10 X 40 MM	EAI1040-SDS-ST

DROP IN ANCHOR / SLEEVE ANCHOR / SHIELD ANCHOR

DROP IN ANCHOR	VARIANT	PRODUCT CODE
 <p>fischer </p> <p>FISCHER</p>	M8 X 30MM	EAI1830
	M8 X 40MM	EAI1840
	M10 X 30MM	EAI1030
	M10 X 40 MM	EAI1040
	M12 X 50 MM	EAI1240

DROP IN ANCHOR / SLEEVE ANCHOR / SHIELD ANCHOR

Setting Tool for Drop In Anchor	VARIANT	PRODUCT CODE
 <p data-bbox="229 1037 416 1070">RAWLPLUG</p>	M8 SETTING TOOL FOR M10 RAWL PLUG DROP IN ANCHORS	R-DCA-ST-08
	M10 SETTING TOOL FOR M12 RAWL PLUG DROP IN ANCHORS	R-DCA-ST-10

DROP IN ANCHOR	VARIANT	PRODUCT CODE
 <p data-bbox="229 1973 416 2007">RAWLPLUG</p>	M8 X 30 MM	R-DCA-08-30
	M10 X 40MM	R-DCA-10-40

SLEEVE ANCHORS

FISCHER	HOLE DIAMETRE	LENGTH	PRODUCT CODE
	10MM	60MM	FSAS1060
		85MM	FSAS1085
		110MM	FSAS10110
	12MM	70MM	FSAS1270
		85MM	FSAS1285
		110MM	FSAS12110
	8MM	60MM	FSAS860
		85MM	FSAS885
		110MM	FSAS8110

PLASTIC WALL PLUG

FISCHER DUOPOWER

FISCHER DUOPOWER WALL PLUG	THREAD SIZE	LENGTH	PRODUCT CODE
	M6	30MM	FDUO-630
		50MM	FDUO-650
	M8	40MM	FDUO-840
		65MM	FDUO-865



RAWL PLUG – RED HDPE PLASTIC PLUG X 100

Code: R-HDP-RED



RAWL PLUG – BROWN HDPE PLASTIC PLUG X 100

Code: R-HDP-BROWN

SHIELD ANCHOR & BOLTS/NUTS

PROJECTING BOLTS (RAWLPLUG)	THREAD SIZE	LENGTH	PRODUCT CODE
	M6	25MM	R-RBL-M06/25W.Q1
		40MM	R-RBL-M06/40W.Q1
	M8	25MM	R-RBL-M08/25W.Q1
		40MM	R-RBL-M08/40W.Q1
	M10	10MM	R-RBL-M10/10W.Q1
		25MM	R-RBL-M10/25W.Q1
		50MM	R-RBL-M10/50W.Q1
		75MM	R-RBL-M10/75W.Q1
	M12	10MM	R-RBL-M12/10W.Q1
		25MM	R-RBL-M12/25W.Q1
		40MM	R-RBL-M12/40W.Q1
		60MM	R-RBL-M12/60W.Q1

SHIELD ANCHOR & BOLTS/NUTS

PROJECTING NUTS (RAWLPLUG)	THREAD SIZE	LENGTH	PRODUCT CODE
	M6	60MM	R-RBL-M06/60W.Q1
	M8	25MM	R-RBL-M08/25W.Q1
	M12	30MM	R-RBL-M12/30W.Q1

SHIELD ANCHOR (RAWLPLUG)	THREAD SIZE	PRODUCT CODE
	M6	R-RBL-M06.Q1
	M8	R-RBL-M08.Q1

HOOK BOLTS & EYE BOLTS

EYE BOLTS	THREAD SIZE	PRODUCT CODE
	M6	HRYE0650B
	M8	HRYE0860B
	M10	HRYE1073B
	M12	HRYE1290B
	M16	HRYE1695B

EYE BOLTS
(RAWL PLUG)

HOOK BOLTS & EYE BOLTS

HOOK BOLTS	THREAD SIZE	PRODUCT CODE
	M6	HUK0650B
	M8	HUK0860B
	M10	HUK1073B
	M12	HUK1290B

HOOK BOLTS (RAWL PLUG)	THREAD SIZE	PRODUCT CODE
	M8	R-RBL-08HW.Q1
	M10	R-RBL-10HW.Q1
	M12	R-RBL-12HW.Q1

HOOK BOLTS & EYE BOLTS

EYE NUTS	THREAD SIZE	PRODUCT CODE
	M6	TEN06.Q1
	M8	TEN08.Q1
	M10	TEN10.Q1

HIGH PERFORMANCE TIMBER SCREWS

WOOD/CHIPBOARD SCREWS (RAWL PLUG)	LENGTH	PRODUCT CODE
	20MM	R-QCP-4020
	25MM	R-QCP-4025
	30MM	R-QCP-4030
	40MM	R-QCP-4040
	60MM	R-QCP-4060
	70MM	R-QCP-4070
	80MM	R-QCP-4080
	100MM	R-QCP-40100



FISCHER RED CONTRACT PLUGS & SCREWS X 500 TUB

Code: FTUBRED



FISCHER BROWN CONTRACT PLUGS & SCREWS X 400 TUB

Code: FTUBBROWN



TWIN-THREADED WOODSCREWS – PZ – DOUBLE COUNTERSUNK – ZINC X 200

Code: 00858CWZ

PLASTER BOARD FIXING

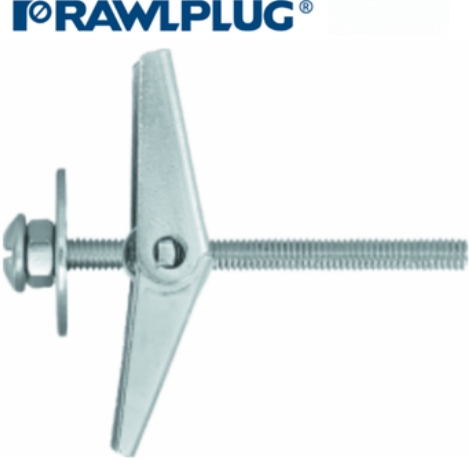
RAWLPLUG	LENGTH	PRODUCT CODE
	M3 X 50	R-QCP-4020
	M5 X 50	R-QCP-4025
	M6 X 50	R-QCP-4030
	M6 X 80	R-QCP-4040